

# Siderise Specification Pack

## Curtain walling



### Application

Products

### Curtain walling

Siderise CW-FS, CW-CB, CW-FB, NXS

Date

January 2025

Revision number

v1.01



# Contents

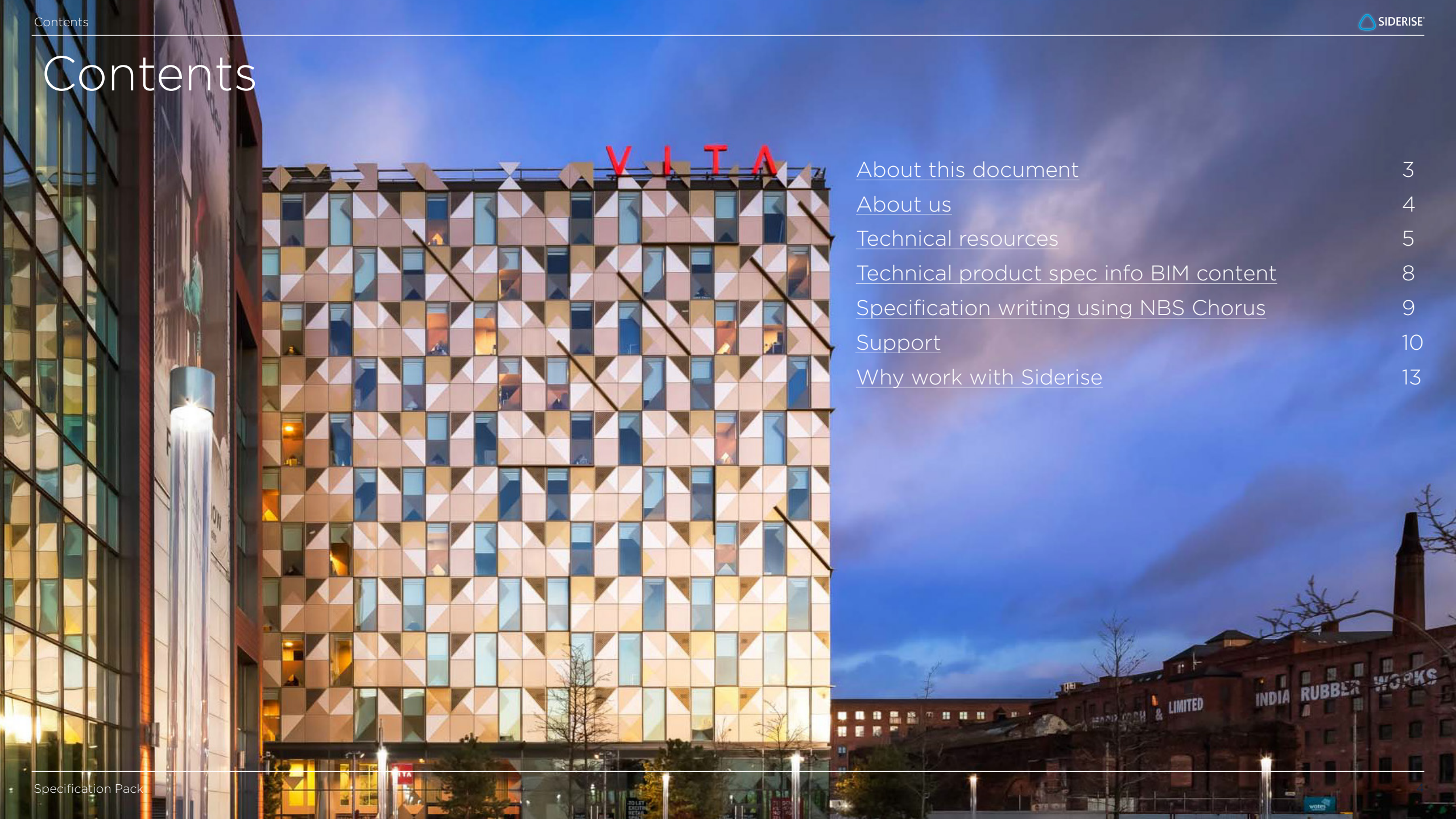

<a href="#">About this document</a>	3
<a href="#">About us</a>	4
<a href="#">Technical resources</a>	5
<a href="#">Technical product spec info BIM content</a>	8
<a href="#">Specification writing using NBS Chorus</a>	9
<a href="#">Support</a>	10
<a href="#">Why work with Siderise</a>	13



# About this document

This Specification Pack summarises the relevant products and systems for the designated application.

It is designed to enable quick access to valued formats of product data including:

- Technical datasheets.
- Third-party certification.
- Standard detail drawings.
- BIM objects.
- Specification information and clauses.
- Installation instructions.

It also introduces our enhanced support services available at different project stages.





# About us

Siderise is a global expert in passive fire solutions for the building envelope. We are also specialists in high performance acoustic and thermal solutions for façade and building interiors, and serve the OEM sectors such as rail, marine and HVAC..

Driven by our ethos of 'integrity in all we do,' we see our role as more than just a product manufacturer. This means taking a holistic approach in understanding where and why our products are used, and how our technical and site services teams can continually support their proper application.

## Affiliations

By actively participating in key technical committees and being a member of trade bodies and industry associations, we seek to not only support the global construction industry in achieving higher levels of fire safety and competency, but also to learn more about the challenges it faces.

## Standards and approvals

Siderise cavity barriers, firestops and cavity trays are manufactured under a management system certified to ISO 9001: 2015, ISO 14001: 2015 and ISO 45001: 2018. [View more](#)



Council for Aluminium  
in Building  
Member



construction  
products  
association



ASFP



Council  
on  
Tall Buildings  
and  
Urban Habitat



CENTRE FOR  
WINDOW AND  
CLADDING  
TECHNOLOGY



INTERNATIONAL FIRESTOP COUNCIL



Institute of  
Acoustics  
sponsoring  
organisation



CSI



Fire Protection  
Association



Fire Sector Federation



INTERNATIONAL  
FIRE SAFETY  
STANDARDS



LEADING ROOFING EXCELLENCE



The Building Envelope Authority



# Technical resources - curtain walling



Product	CW-FS Horizontal and Vertical Firestop and CW-CB Vertical Cavity Barrier
Webpage	<a href="#">CW-FS Firestop and CW-CB Cavity Barrier</a>
Technical datasheet	<a href="#">CW-FS and CW-CB Technical datasheet</a>
Third-party certification	<a href="#">CW-FS and CW-CB Third-party certification-All</a>
Installation instructions	<a href="#">CW Installation instructions</a>
Standard details	<a href="#">CW-FS and CW-CB Standard details library</a>
Additional information	<a href="#">CW-FS Declaration of Performance (DoP)</a>
Environmental Product Declaration (EPD)	<a href="#">CW EPD</a>
CCPI	<a href="#">CW-FS and CW-CB Assessed Product Information CCPI</a>





# Technical resources - curtain walling

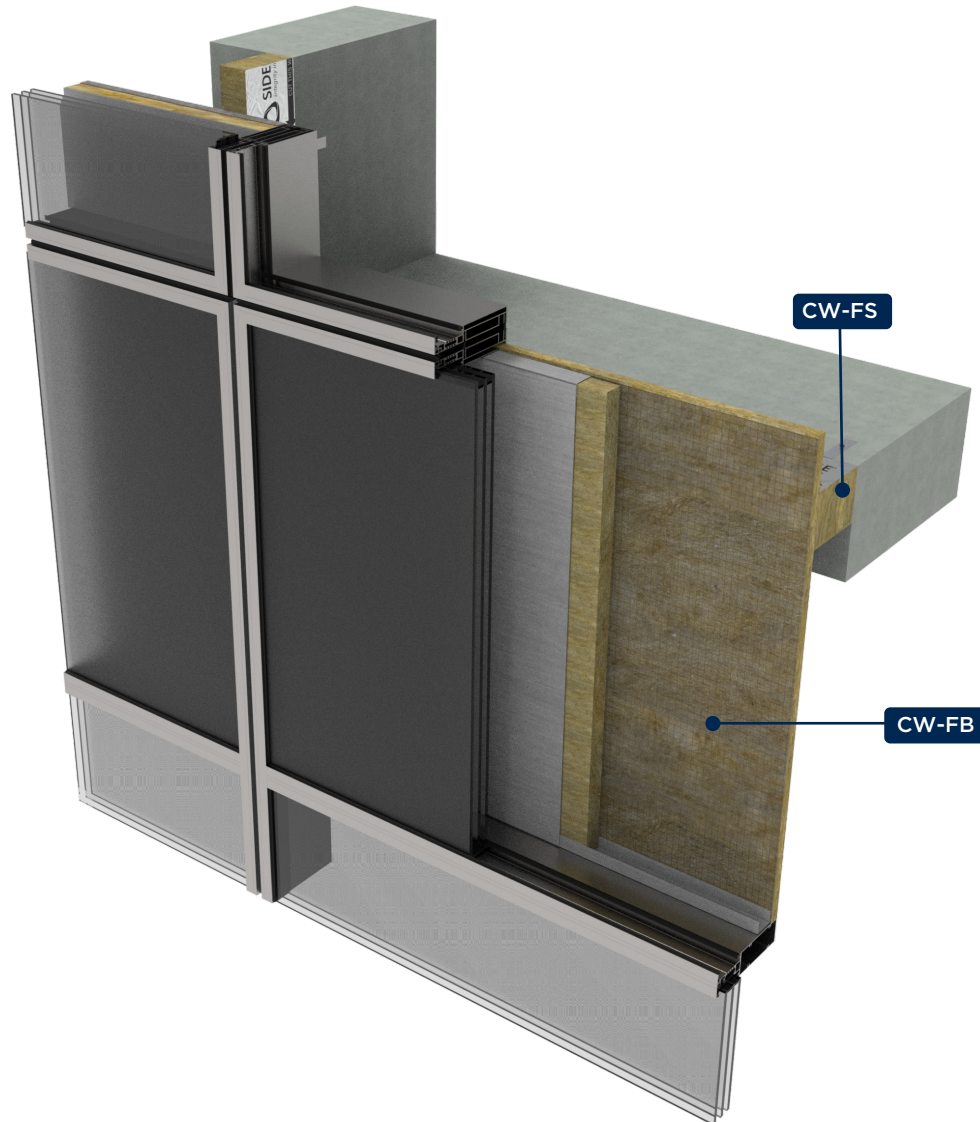

Product	CW-FB Fireboard
Webpage	<a href="#">CW-FB Fireboard</a>
Technical Datasheet	<a href="#">CW-FB Technical datasheet</a>
Third-party certification	<a href="#">CW-FB Third- party certification - All</a>
Installation instructions	<a href="#">CW-FB Installation instructions - Inset</a> <a href="#">CW-FB Installation instructions - Full spandrel</a>
Standard details	<a href="#">CW-FB - Standard details library</a>





# Technical resources - curtain walling

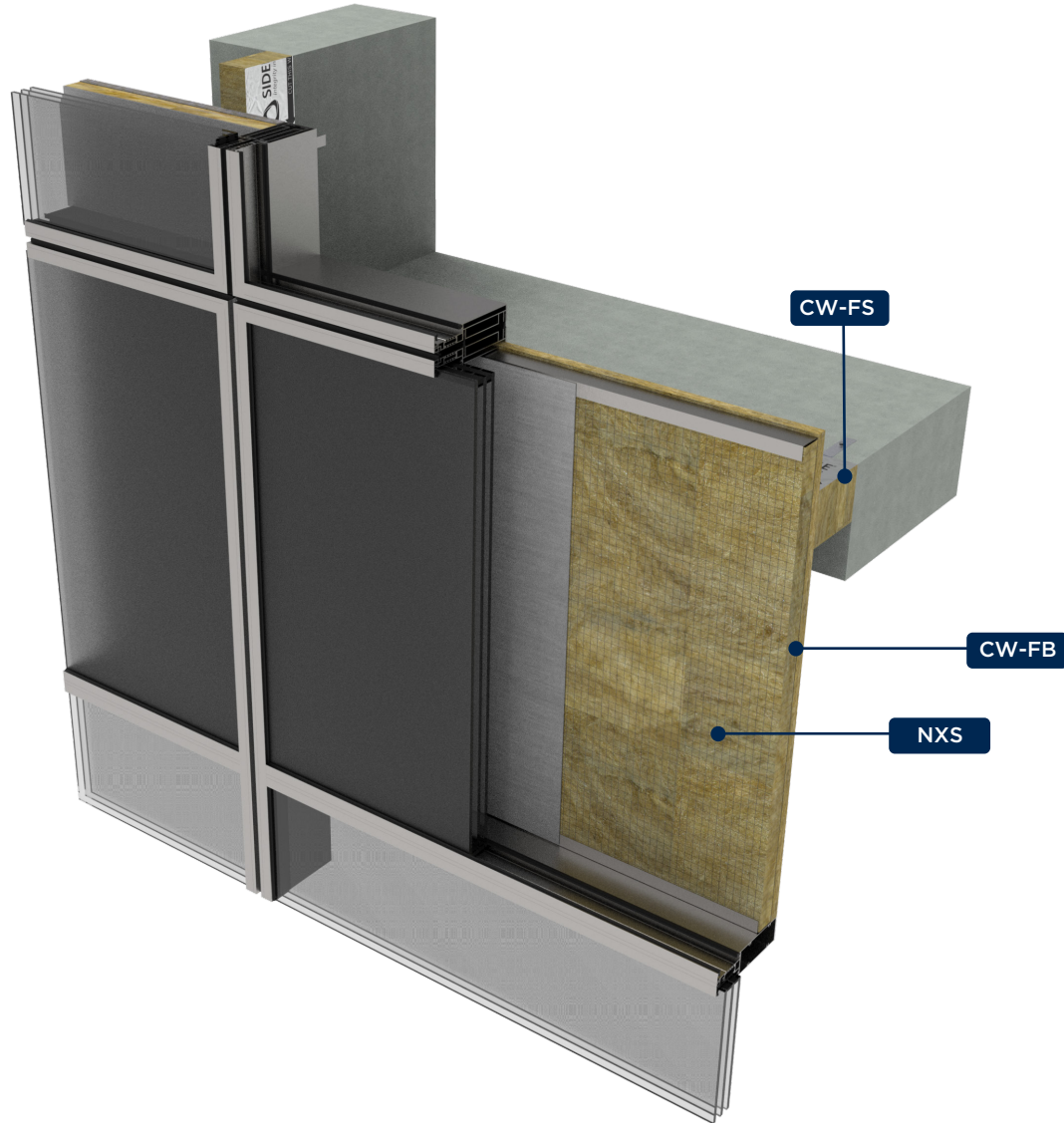

Product	NXS Nexus Fusion Insulation
Webpage	<a href="#">NXS Nexus Fusion</a>
Technical datasheet	<a href="#">NXS Technical datasheet</a>
Standard details	<a href="#">NXS Standard details library</a>



# Technical product specification information/BIM Content hosted on specification platforms

We are proud to provide accessible and free to download BIM models for our products hosted on both bimstore and NBS.

BIM objects in the National BIM library within NBS Source, have been authored to meet the requirements of the NBS BIM Object Standard (BOS), enabling comparisons and analyses between objects that satisfy the standard.

**Select your chosen platform - both are free to use.**

Find our products on bimstore with access to:

- Specification data**
- Downloadable BIM content**
- Object user guide**

[Go to bimstore](#)



We are an NBS Partner. Find our products on NBS Source with access to:

- Specification data**
- Downloadable BIM content**
- Case studies**

[Go to NBS Source](#)



# Specification writing using NBS Chorus

Our NBS Chorus licence allows us to assist you with generating robust product specifications tailored to your project application.

NBS structured specification clauses are available for our standard passive fire protection, cavity tray and noise control products.

NBS Chorus product specifications ('specs') are concise yet detailed and contain clear physical and functional descriptions.

They can be formatted to suit your process. Choose from MS Word or PDF. If you have an NBS Chorus licence, click 'Add to spec' in NBS Source. Alternatively, we can share the specification with you through NBS Chorus.

**Email:** [projects@siderise.com](mailto:projects@siderise.com)



Specification writing partner

+  Add to spec

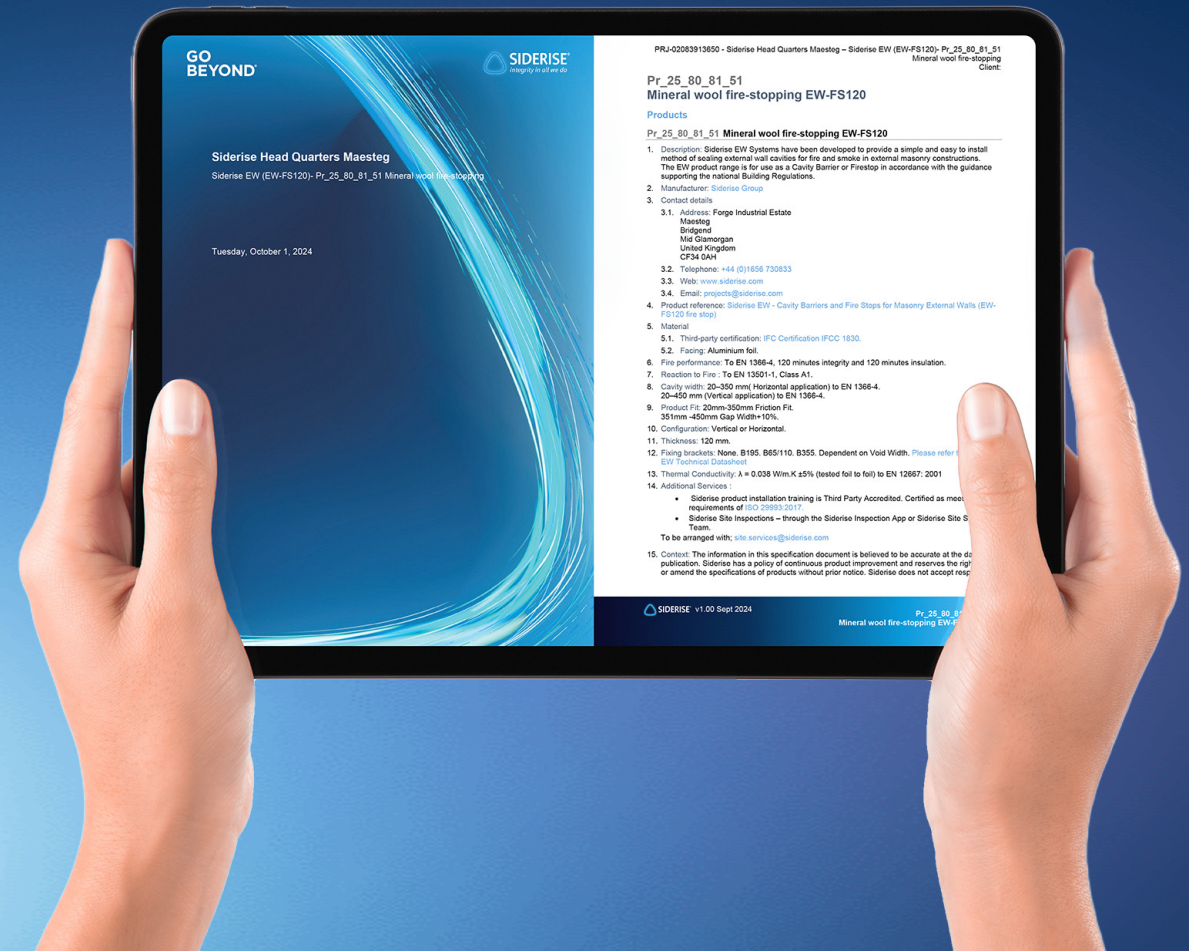



# Support

In addition to our comprehensive library of information, our technical support team can help you with the relevant product specification for the application. We can also help build a bank of information that can be used to contribute to the Golden Thread, and which can assist you when conducting due diligence.

## Design and specification

- **CPD Seminars** - email: [cpd@siderise.com](mailto:cpd@siderise.com).
- Design feedback.
- Technical datasheets and parameter guidance.
- Example detail drawings and AR 3D visualisations.
- Standard details of example façade arrangements.
- Project specific product suitability advice.
- Technical detail drawing reviews and overlays.
- Method statements and sequencing information.
- Mock-up constructions and product samples.



Learn more about design and specification support







## Training SIDERISE ACADEMY

together, we're building confidence

- CPD seminars in-person or livestream.
- Webinars live and on-demand.
- Online learning courses and educational e-modules.
- ASFP Recognised product and application specific training programmes in-person at Siderise HQ.
- National training roadshow events by invitation.



[Learn more about training](#)

## Testing

- Project specific product level testing.
- Bespoke fire testing facilitation for unusual applications or ambitious designs.



[Learn more about testing](#)

## Golden Thread

- Final inspection reports with photo records of installation.
- Digital report of recorded interactions.
- Technical communications history.
- Training records.
- Quotations and transactional data.
- BSI identify product identification and traceability.





## Site training

Our product installation training program is designed for installers, site supervisors and site managers to help them learn how to correctly install our products. It is an effective classroom and practical learning process that has resulted in consistently high-quality workmanship from project stakeholders we have worked with.



### Benefits:

- ASFP Recognised training that can be used within the ASFP Competency Pathway.
- Certified training delivery method to ISO 29993: 2017.
- Benchmark mock-ups.
- Toolbox talks.
- Review of difficult detailing.
- Guidance on good workmanship.
- Advice on preventing 'built in' errors.
- Identify if installation meets recommendations.



[Learn more about site training](#)

**ASFP**  
Recognised Provider

## Installation inspection

Our free periodic inspection service, either in-person or via our app, can help verify installation quality, meets required workmanship standards in line with our instructions, and identify if remedial action is needed. To assist with the 'Golden Thread', data for all our standard firestop, cavity barrier, cavity tray and acoustic barrier systems is compiled into a digital report.



### App benefits:

- Download on smartphone, tablet or desktop.
- Easy to use with a user-friendly interface.
- Exercise due diligence.
- Record and monitor installations.
- Upload photo evidence.
- Audit workmanship standards.
- Share the project with other stakeholders if required.
- Reviewed within 48hrs by our Technical Team.
- Data legacy - access historical submitted reports.



[Learn more about the App](#)





# Why work with Siderise

## Competent people

Under CCPI, anyone conveying 'Product Information' must be competent to the right level of knowledge. Our technical staff undergo formalised training with ongoing upskilling to ensure sufficient product knowledge, and with a view to achieving professional qualifications provided by the Institution of Fire Engineers (IFE).

This enables design or product suitability advice that is backed by clear product data to be delivered by someone competent enough to interpret project requirements, understand any potential parameters or limitations, and identify the right solutions to enable compliance.

## UKAS ISO 17025 accredited Innovation Centre

Featuring a specialist fire test furnace and data logging equipment, our Centre enables us to test products to any published fire test curve to BS, EN, ASTM, UL, and ISO standards with capacity for 200+ tests annually. This allows us to not only conduct our own research and development, and quality control testing in house but to also to expand our bespoke solution offering. [Read full story.](#)

## Quality control for product quality and safety

In line with the recommendations of the Independent Review of the Construction Product Testing Regime and its calls for manufacturers to take ownership of quality, our laboratory facilitates off-the-line fire testing and comprehensive testing of raw materials before production to ensure our products offer outstanding performance. We also conduct stringent incoming checks on key materials from suppliers.





# Why work with Siderise



## Advocates of testing and third-party certification

Testing and certification are the cornerstone of our offering. Our commitment to an expansive programme of testing, partnering with industry stakeholders all over the world, has provided us with a considerable amount of test data about the specific applications our products are developed for, whilst helping us find new and verified ways to approach passive fire protection - new product ideas are often born from collaboration with project partners and the real-life challenges they face. [Learn more.](#)



## Vast international project experience

Our global presence spanning Europe, the Middle East, the US, India, Asia Pacific, and beyond means that we have been involved with some of the most unusual and challenging projects. Drawing on these project experiences, we can apply our cross-border technical wisdom to continually support the proper application of our products. We also have a strong network of in-country partners with local knowledge and on-the-ground expertise. [See case studies.](#)



## Committed to sustainable development

To ensure growth is conducted in a sustainable way, we have formulated a clear Environmental, Social and Governance (ESG) strategy, consisting of four key pillars: Planet, People, Product, and Policy, ensuring that our business operations and ambitions align with recognised Sustainable Development Goals (SDGs).

[View our strategy.](#)









**Siderise Insulation Ltd**

Forge Industrial Estate  
Maesteg  
Bridgend CF34 0AH  
United Kingdom

 [Contact us | Siderise](#)

 01656 730 833

 [enquiries@siderise.com](mailto:enquiries@siderise.com)

 [www.siderise.com](http://www.siderise.com)

**Disclaimer**

The information published herein is given in good faith and is believed to be accurate at the time of publication. Images shown are for illustration purposes only. Annotations on the appended details demonstrate the most appropriate Siderise products for the application. The scope of our feedback and overlays is limited to Siderise products only and does not include or consider the performance or suitability of any other components / products within the details, or the performance of the detail as a whole. Siderise has a policy of continuous product improvement and reserves the right to alter or amend the specifications of products without prior notice. Siderise does not accept responsibility or the consequences of using the products and systems described outside of any given recommendations within this document or its other official documentation. Recommendations for use should be verified regarding the suitability and compliance with actual requirements, specifications and any applicable laws, codes, and regulations. Expert advice should be sought where there is any doubt about the correct specification or installation of Siderise products and systems.